

27661	ENJOLIVEUR SUPERIEUR	1
27423	COTE DROIT D.A.	1
27380	SUPPORT CORPS DE CHAUFFE	2
27378	COTE GAUCHE D.A.	1
27377	COUVERCLE DISTRIBUTEUR D'AIR	1
27376	ENJOLIVEUR DROIT	1
27375	ENJOLIVEUR GAUCHE	1
27373	PROTECTION DE SOL	1
27372	TRAVERSE LATERALE DE	2
CODE ARTICLE	DESIGNATION	QTE

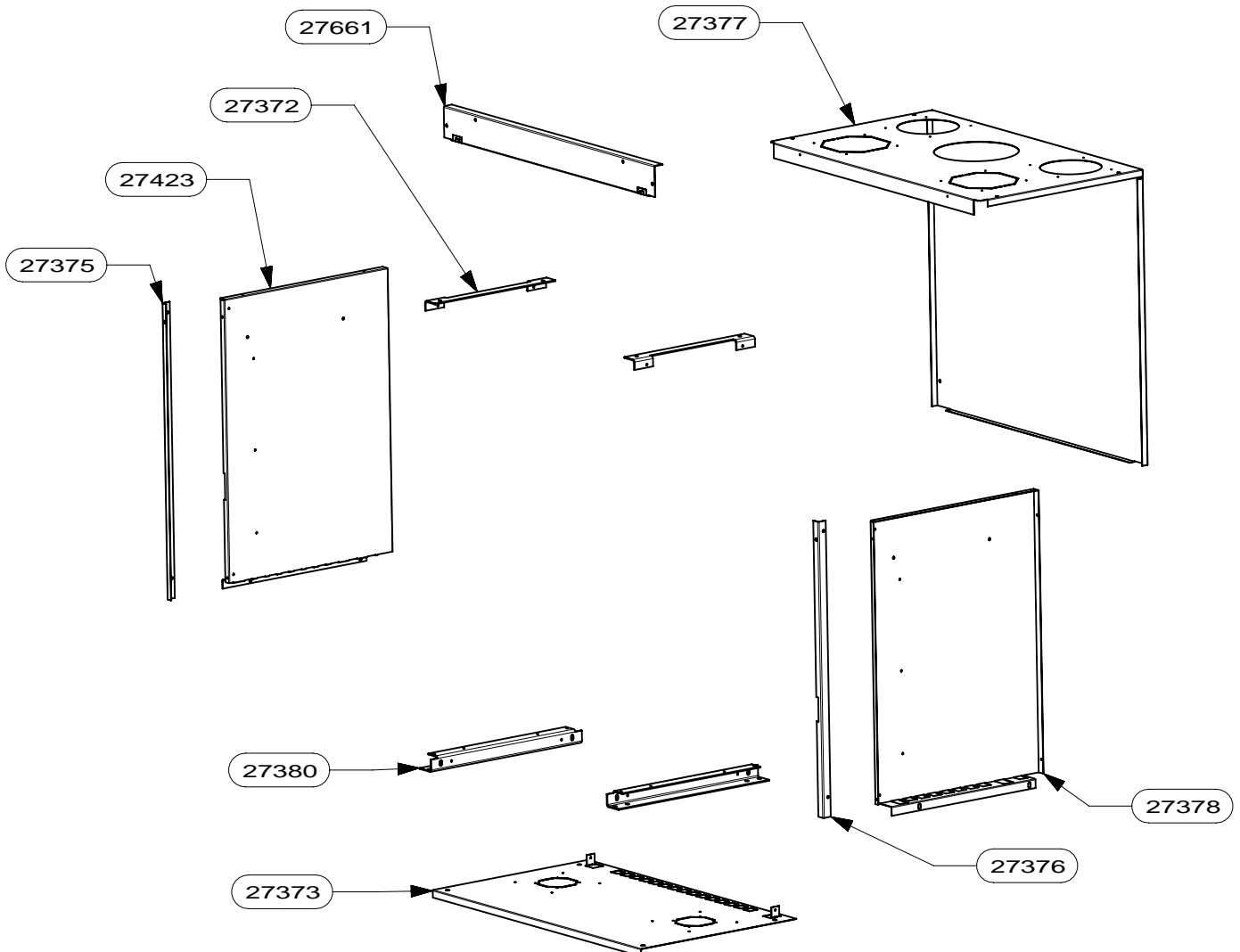

33197	FACADE FOYER HIRVIK V19 EM	1
32607	CALE	2
32606	TRAVERSE INFERIEURE	1
32605	TRAVERSE SUPERIEURE	1
32604	MONTANT D'ACCROCHAGE	2
11138	VIS A TOLE HEXAGONALE	6
07370	VIS A TETE CYLINDRIQUE 6 PANS CREUX	8
04606	VIS A TETE RONDE LARGE POZI	2
CODE ARTICLE	DESIGNATION	QTE

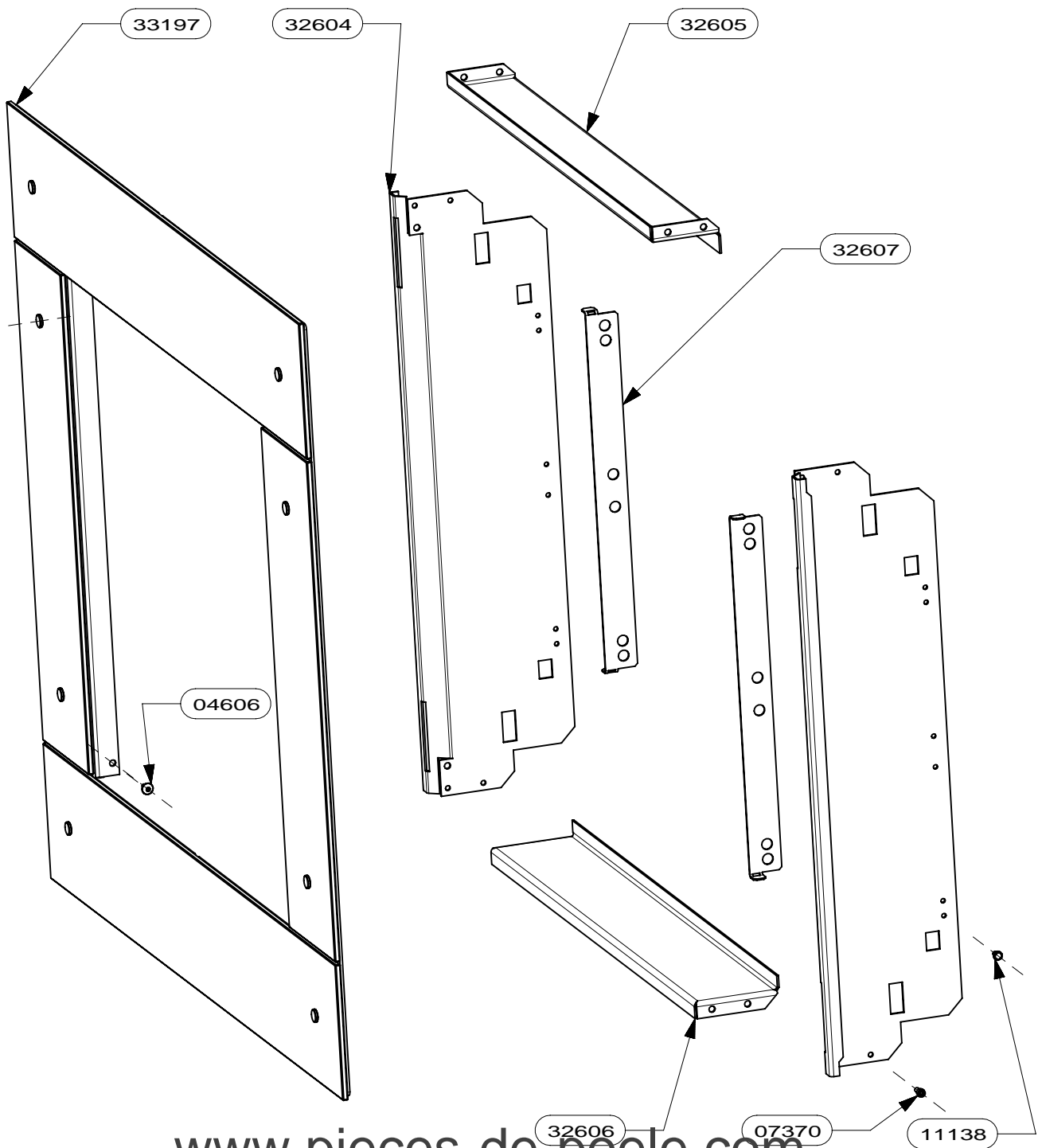

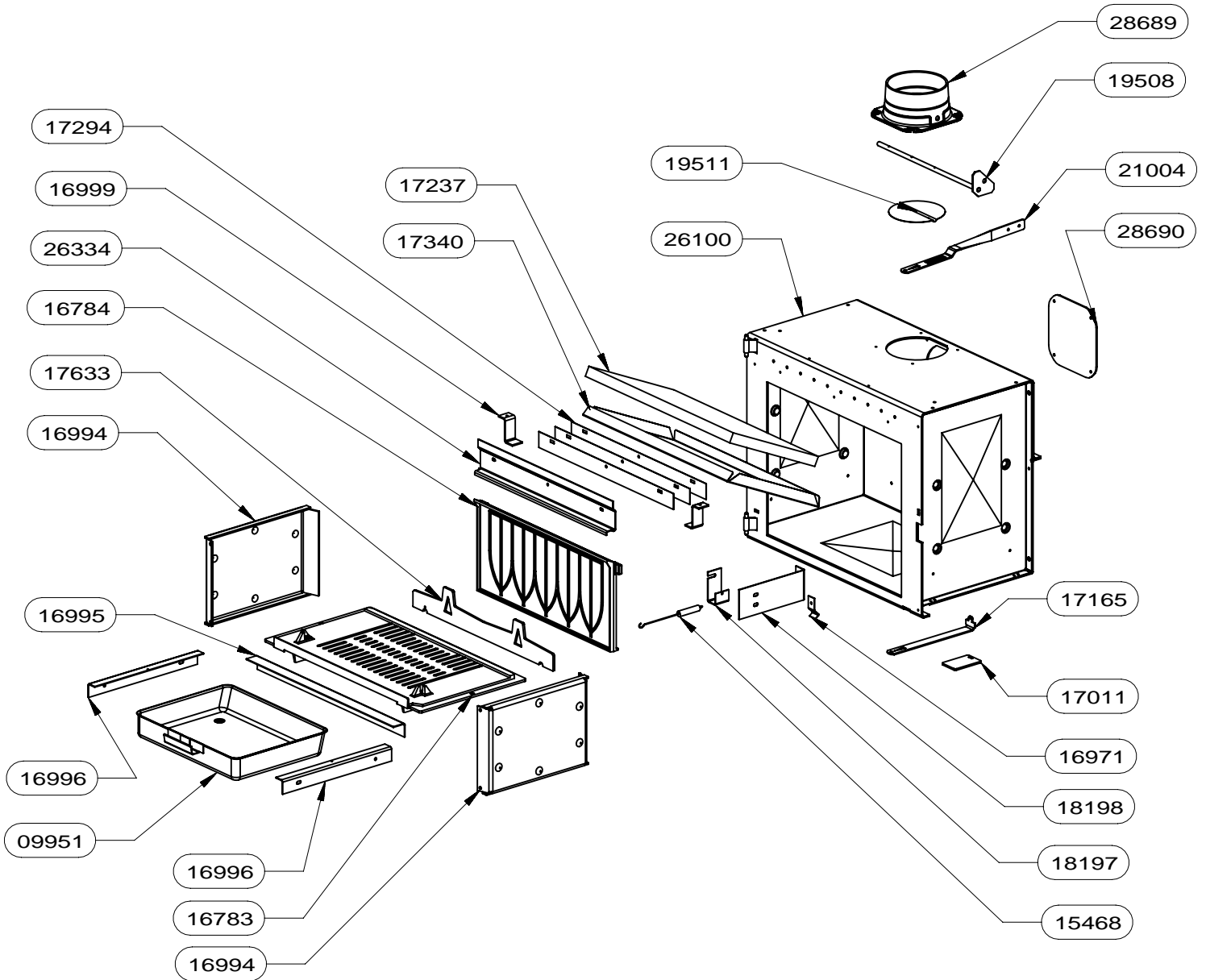

26334	DEFLECTEUR VITRE	1
26100	SOUS-ENSEMBLE CORPS DE CHAUFFE	1
21004	TIRETTE COMMANDE CLAPET	1
19511	CLAPET DE BUSE D133	1
19508	AXE DE CLAPET E.S.	1
18198	ATTACHE DE RESSORT	1
18197	FIXATION ATTACHE	1
17633	CHENET HF2959	1
17340	DOUBLAGE DEFLECTEUR INOX	1
17294	CALAGE DEFLECTEUR DE VITRE	3
17237	DEFLECTEUR VERMICULITE	1
17165	TIRETTE AIR DE GRILLE	1
17011	REGISTRE D'AIR	1
16999	PATTE D'ACCROCHAGE	2
16996	EQUERRE	2
16995	APPUI ARRIERE DE SOLE	1
16994	COTE INTERIEUR DE CORPS DE CHA	2
16971	RESSORT DE FERMETURE PB50	1
16784	PLAQUE D'ATRE CONTEMPORAINE	1
16783	SOLE	1
15468	RESSORT DE TRACTION	1
09951	ENS.SOUDE CENDRIER	1
CODE ARTICLE	DESIGNATION	QTE

91139	ENSEMBLE MONTE POIGNEE RONDE	1
26715	BAVETTE	1
26336	FIXE VITRE DROIT	1
26335	FIXE VITRE GAUCHE	1
26332	PROTEGE JOINT	2
26331	ENTRETOISE	2
26329	VITRE 605x497x3	1
26207	PORTE MIXTE	1
16992	FIXE JOINT LATERAL	2
16991	FIXE JOINT HORIZONTAL	1
16974	JOINT DE PORTE LG.500	1
16973	JOINT DE PORTE LG.415	2
05891	JOINT FIBRE AUTOCOLLANT D8 LG 1800	1
04093	JOINT PLAT AUTOCOLLANT 10x2 LG.320	2
CODE ARTICLE	DESIGNATION	QTE

